



# WINTON FLAIL MOWER WHF SERIES



**OWNERS MANUAL**

**PLEASE READ THIS MANUAL BEFORE OPERATING THE MOWER**

Congratulations on purchasing your new **Winton** mower!

Before you get started, we have provided a helpful space to jot down a few important details about your new Winton machine.

Model Number: **WHF**

Serial Number:

Date of purchase:

Factory Reference: EFGCHM125/EFGCHM145/EFGCHM175/  
EFGCHM200/EFGCHM220

This manual should be considered a permanent part of this machine and should remain with it even if the machine is subsequently sold.

Winton continually seeks advancements in its product design and quality. Therefore, while this manual contains the most current product information available at the time of printing, there may be minor discrepancies between your machine and this manual.

If you have any questions concerning this manual, please consult your local dealer.

First Published: December 2017

## General Safety Information

Ensure all potential operators read this manual thoroughly before using the machine.

**Safety:** Ensure tractor and machine is stationary and keys out of ignition before set-up/maintenance.

**Safety:** Failure to follow good safety standards could result in severe injury or even death.

**Misuse:** This machine is designed for use with compact tractors, and should be used only for the indicated purpose. Winton does not take responsibility if the machine is used for any other purpose. Children must not operate the machine under any circumstance.

**Modification:** Do not modify equipment in any way. This may impair the operation and overall safety of the machine.

**Tractor requirements:** Use only with compact tractors within power range specified.

**Misuse transport:** Do not use machinery to transport personnel or livestock.

**Condition:** For the safety of personnel and optimum performance of the machine, you should check the condition of the machine and the tractor before starting. Before use check all nuts and bolts are tight.

**Spatial awareness:** Always check the operating area is safe before starting machinery.

**Operator clothing:** The operator should not wear loose clothing while operating machinery.

**Safety wear:** Always use appropriate ear protection when running a tractor and machinery. Ensure you are wearing protective gloves when servicing and using machinery.

**Bystander safety:** Ensure bystanders keep away from the machine when it is in use. Do not touch moving parts when the machine is at work.

**Public places:** When travelling on the road/public places, always keep the PTO turned off.

**Maintenance:** Always keep the machine maintained and in a good state. Where necessary, repair or replace any defective parts. Do not modify the machine.

**Sharp objects:** Pay attention to the sharp/pointed parts while servicing the machine.

**Safety guards:** All protective parts should be in good condition before operating machinery.

**Safety signs/stickers:** Keep all safety signs clean and legible. Replace any which are missing or illegible. If a component with safety sign(s) is replaced, make sure new safety sign(s) are attached in the same locations.

**Operating speeds:** Machinery and PTO should be operated at the recommended speed at all times.

**Safety awareness:** Good safety requires that you familiarise yourself with various safety signs, the type of warning and the area, or particular function related to that area.

**Alertness:** Never consume alcohol or drugs as these can hinder alertness/coordination. Consult your doctor about using this machine while taking prescription medications.

## General Safety Information (Continued)

### Machinery Pre-Use Checks

On receipt of your new Winton machine and again within the first 4 hours of use, or the 'shake in period', we always recommend checking over the machine.

- Check all bolts, nuts and screws are tight on the unit.
- Tighten/check any bolts and nuts securing blades.
- If your machine has belts check the tension and adjust if required.
- Apply grease to grease points if necessary.
- Check gear oil level and top up if needed. Do not overfill.

### Tractor Pre-Use Checks

Check that the machine is properly attached to the tractor. Ensure that secure pins are used on the linkage mounting pins.

Be sure to add extra weights to the front of the tractor or add wheel weights if required.

Check that the tractor PTO shaft turns freely and that the machines PTO drive shaft can extend easily. Grease the PTO drive shaft using the grease points.

The chain on the PTO shaft should be checked and in a good condition. The universal joints installed should be in a good state, with proper protective parts.

Before installing the PTO shaft, the tractor and machine should be stopped and the key removed.

Install and secure all safety guards, doors and covers before starting.

Bystanders should leave the immediate area before connecting the drive to the tractor.

### Running/Operating Checks

- Always keep the PTO output from the tractor at **540 RPM** when running machinery.

### Post-Use Regular Checks





Check blades, belts and wearing parts. Be sure they are not damaged and blades swing freely in their mount. Repair or replace as required.

Clean machinery and check for/clear any entangled material which may have got stuck around the rotating parts.

## Contents

	Pg.
General Safety information	1-2
1. Dimensions and Specifications	4
2. Installation & Set Up	5-6
3. Cutting Height Roller & Skid Adjustment	7
4. Gear Oil Change & Check	8-9
5. Adjusting Belt Tension	10-11
6. Hydraulic Fitting & Operation (WHF)	12-13
7. Servicing & Maintenance	14-15
8. WHF Parts Diagram 4	16
9. WHF Parts List 4	17-19
10. WHF Parts Diagram 5	20
11. WHF Parts List 5	21
12. WHF Parts Diagram 6	22
13. WHF Parts List 6 (125/145/175)	23
14. WHF Parts List 6 (200/220)	23
15. Notes	24
PTO Shaft Resizing	25
Winton Product Warranty	26
Trouble Shooting	27

## 1. Dimensions & Specifications

Model	WHF125	WHF145	WHF175	WHF200	WHF220
Weight	312kg	322kg	350kg	451kg	500kg
Working Width	125cm	145cm	175cm	200cm	220cm
Hammer Flail Type					
Number Of Flails	20	24	28	32	36
Recommended Tractor HP	20-40 HP	25-50 HP	30-55 HP	35-60 HP	40-70 HP
Width	140cm	160cm	190cm	215cm	235cm
Depth	95cm	95cm	95cm	95cm	95cm
Height	95cm	95cm	95cm	95cm	95cm
PTO Shaft Size	70-100cm	70-100cm	70-100cm	70-100cm	70-100cm
Cutting Height	3-8cm	3-8cm	3-8cm	3-8cm	3-8cm
Linkage Size	Category 1	Category 1	Category 1	Category 1	Category 1
Number Of Drive Belts	3	3	3	4	4
Hydraulics Required	1x Double acting spool	1x Double acting spool	1x Double acting spool	1x Double acting spool	1x Double acting spool
Hydraulic Shift Distance	32cm	32cm	32cm	32cm	32cm

## 2. Installation & Set Up

**Safety:** Ensure tractor and machine is stationary and keys out of ignition before set-up/maintenance.

**Safety:** Before attaching/detaching machinery ensure the hydraulic lift system is in a neutral position.

**Safety:** Make sure the PTO drive isn't connected at any point until instructed to do so.

You will need:

Your tractor, tractor top link arm (adjustable), linkage pins, PTO shaft & some elbow grease!

Attaching The Mower

Start by finding a flat piece of ground. Lower the three point linkage on your tractor to its lowest position and attach the mower to the tractor using the three point linkage pins and linch pins.

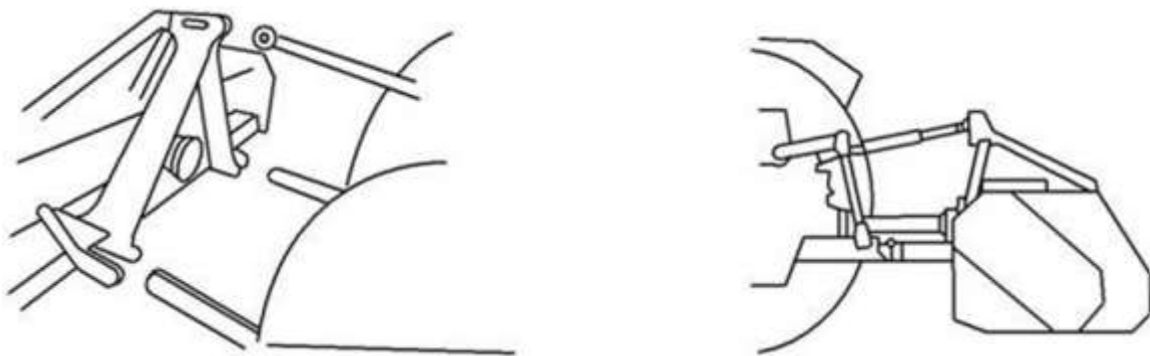

Attach the hydraulic connections [see section on hydraulic fitting & operation]. Then, with the rear roller on the mower on the ground, adjust the length of the top link arm and use the tractor hydraulics to ensure the skids at the side of the flail mower are parallel with the ground when horizontal.

Then rotate the blade rotor by hand so that a row of blades hang vertically towards the ground to give an idea of the cutting height. Check the clearance between the bottom of the blades and the ground, this should be at least 30mm.

The cutting height can be set for longer grass by simply raising the hydraulic lift arms on your tractor or/and by adjusting the rear roller and skids on the machine to increase or decrease the blade clearance as required [see section on adjusting the cutting height].

The working speed of the machine should always be at a walking pace (approx. 2 to 5 mph) depending on the working conditions. Overgrown grass and weeds should be cut at a much slower pace for the best cut and to avoid any damage to the mower.

Check your PTO shaft's grease points and apply grease if needed. Then attach the PTO drive shaft and ensure the locking pin is secure on both the tractor and mower sides. Attach the chain to a secure point on the tractor/implement.

Operate the flail mower the with tractor in low range gear and the PTO delivering 540 RPM.

## 2. Installation & Set Up (Continued)

**Safety:** Ensure tractor and machine is stationary and keys out of ignition before set-up/maintenance.

**Safety:** Before attaching/detaching machinery ensure the hydraulic lift system is in a neutral position.

**Safety:** Make sure the PTO drive isn't connected at any point until instructed to do so.

### Pre-Mowing Checklist

Before starting the machine, always check and adjust the following:

- Set correct cutting height [Section 3]
- Oil level of the gearbox [Section 4]
- Tension of the drive belt [Section 5]
- Hydraulic fitting & operation [Section 6]
- Lubrication/grease points [Section 7]
- Tightness of all bolts, nuts and screws.
- All protective guards are in place before operating.



### 3. Cutting Height Roller & Skid Adjustment

**Safety:** Ensure tractor and machine is stationary and keys out of ignition before set-up/maintenance.

**Note:** Clearance of blades to the ground should be at least 30mm and higher on uneven ground.

Getting the cutting height right is the key to creating the best cut and finish when mowing. This needs to be adjusted depending on the lay of the land and also the length of grass and density of weeds.

The cutting height can be set for longer grass by simply raising the hydraulic lift arms on your tractor or/and by adjusting the rear roller and skids on the machine.

#### Roller Adjustment

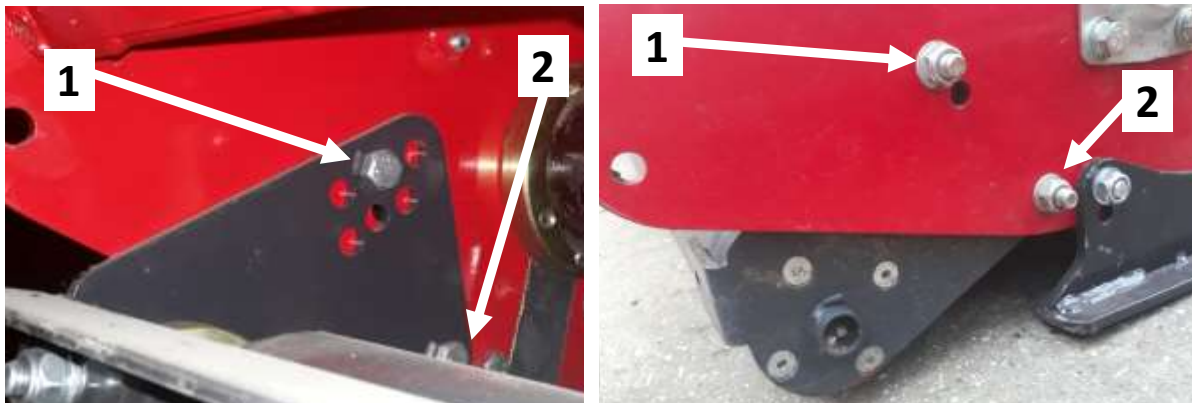

1. Remove bolt **(1)** on both sides of the machine.
2. Adjust roller by aligning the selected hole in the roller support bracket at position **(1)** (using the hole closest to the ground gives the highest working height).
3. Put bolt **(1)** into the selected hole and re-tighten bolt **(1)**.

#### Skid Adjustment

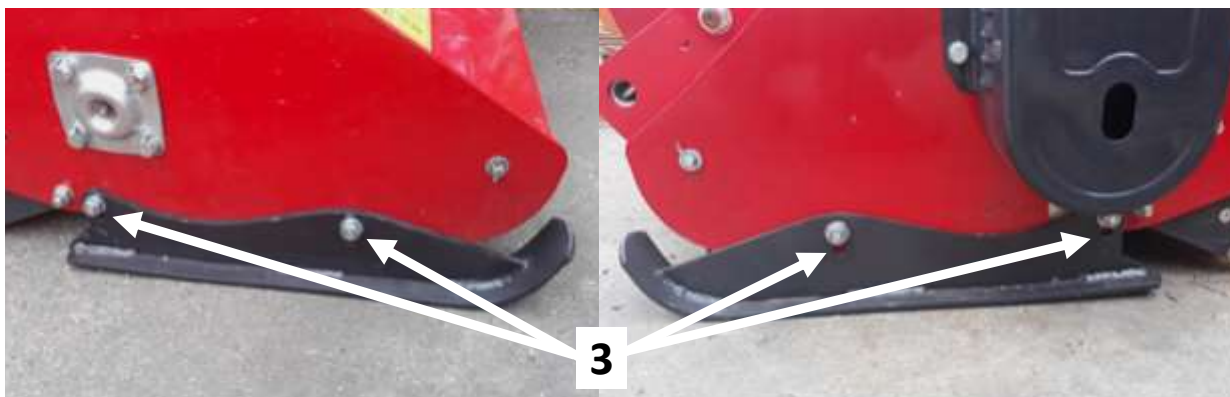

1. Remove bolts and nuts **(3)** on the front & back of both sides of the machine.
2. Move the skids up or down to the desired bolt hole height.
3. Re-insert bolts and nuts **(3)**.

## 4. Gear Oil Check & Change

**Safety:** Ensure tractor and machine is stationary and keys out of ignition before set-up/maintenance.

### Important Information

Gear Oil Grade	80w90 (GL5 grade) gear oil for all conditions (or equivalent)
Gearbox Oil Level	Approx. 0.5 litres to level plug
Level Plug Size	8mm Allen key
First Oil Change	50 hours use
Oil Change Frequency	250 hours/yearly (whichever is first)

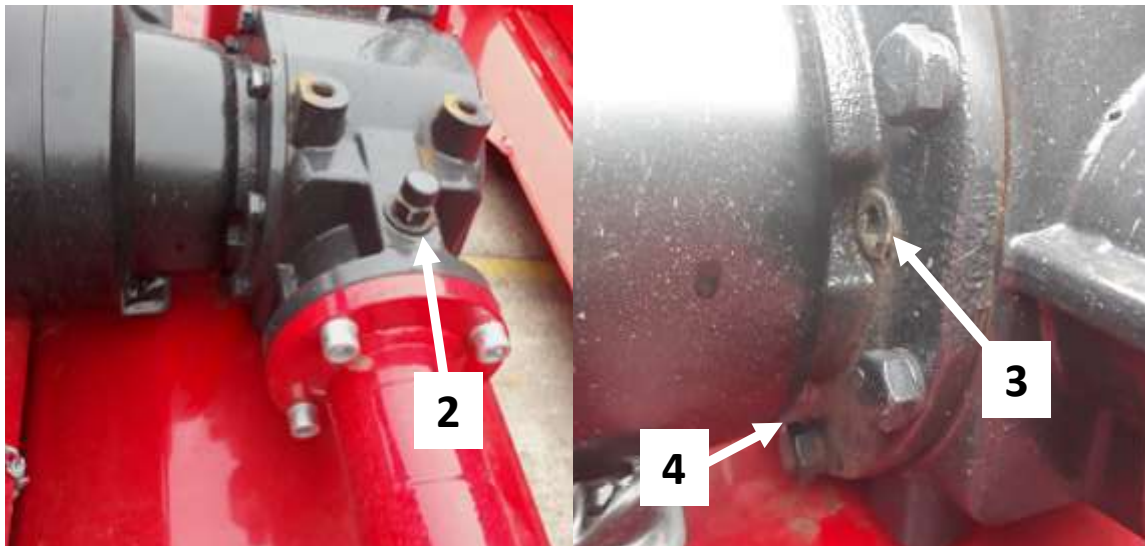
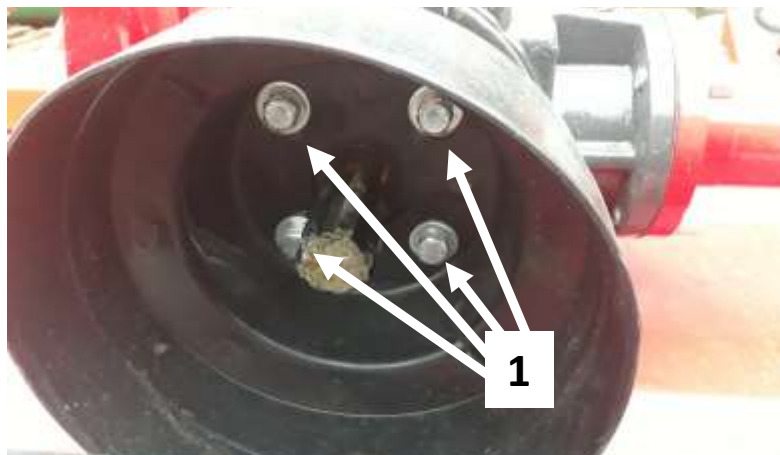

### Oil Change/Check Gearbox

1. Remove the PTO guard on the gearbox for best access, do so by removing bolts **(1)**.
2. Remove filler/breather plug **(2)** and level plug **(3)**.
3. Add oil through the filler/breather plug hole **(2)** until it reaches/begins to weep from the level plug hole **(3)**.
4. Re-install both plugs **(2 & 3)** and reattach the PTO guard.

## 4. Gear Oil Check & Change (Continued)

**Safety:** Ensure tractor and machine is stationary and keys out of ignition before set-up/maintenance.

Draining oil: Plug **(4)** underneath the gearbox PTO guard can be used when draining oil or alternatively use an oil pump.

Bolt tension: Always make sure bolts are tightened correctly. The filler/level plug should be secure but not over tightened.

### Oil Change Log

Oil Change #1	Oil Change #2	Oil Change #3	Oil Change #4	Oil Change #5	Oil Change #6
/ /	/ /	/ /	/ /	/ /	/ /

## 5. Adjusting Belt Tension

**Safety:** Ensure tractor and machine is stationary and keys out of ignition before set-up/maintenance.

### Correct Belt Tension

The correct belt tension is achieved when the belt can be deflected by the belt thickness about 10mm at the centre point between the pulleys. Tension should be checked regularly.

As a general rule across machines, the belt should be able to twist a quarter turn by hand. Any more means they are too loose and any less they too tight. In this situation, you may run the risk of losing drive to the mower or burning the belts out prematurely.

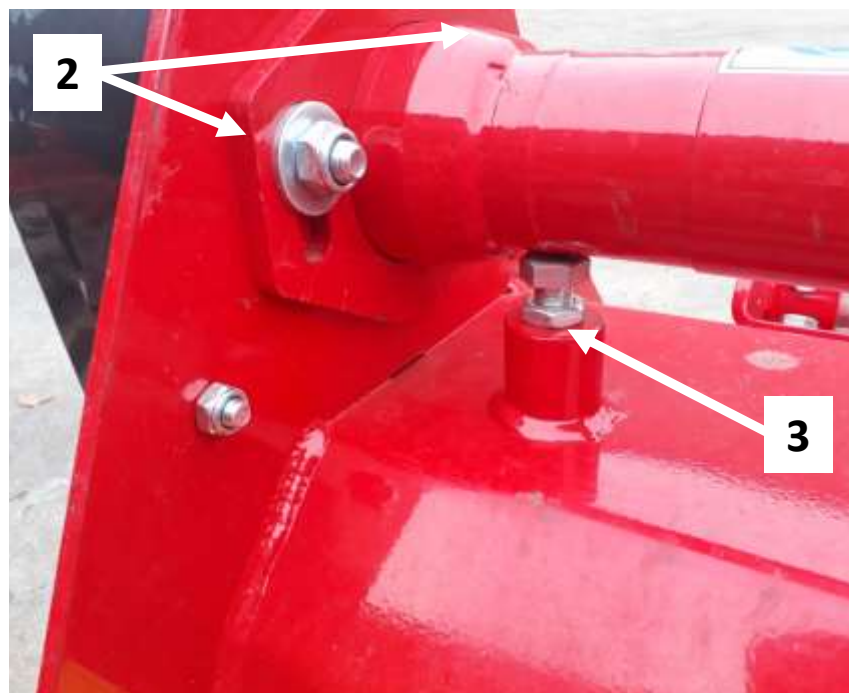
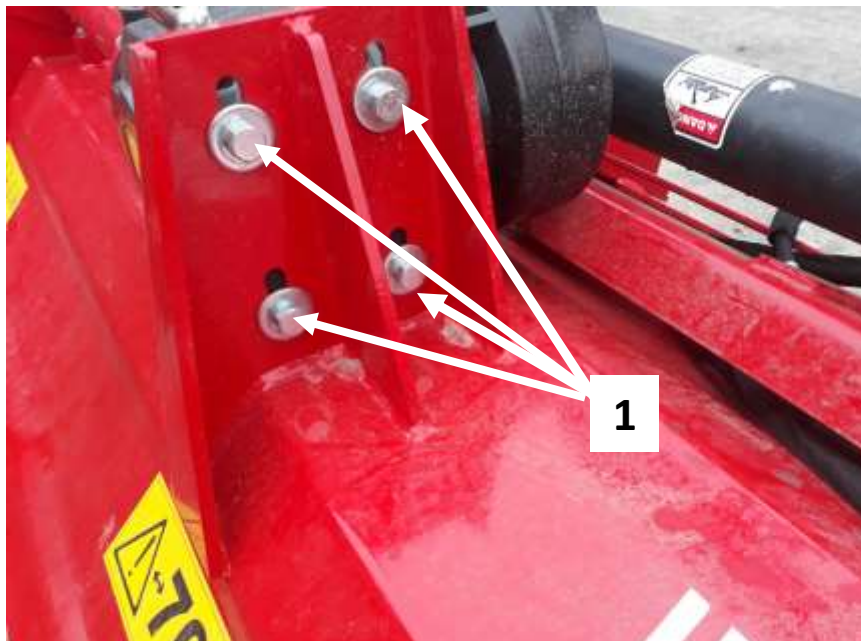

## 5. Adjusting Belt Tension (Continued)

**Safety:** Ensure tractor and machine is stationary and keys out of ignition before set-up/maintenance.

### Belt Tensioning

1. Remove the belt cover **(4)**.
2. Loosen the four bolts **(1)** securing the gear box to the mounting plate.
3. Loosen bolts **(2)** on the back of the belt guard housing, holding the support shaft.
4. Loosen off the counter locking nut **(3)**.
5. Adjust belt tension by adjusting the height of counter nut **(3)**.
6. Align the gearbox ensuring the drive shaft is parallel with the body and re-tighten nuts.
7. Re-tighten all bolts.
8. Replace the belt cover.

Ensure that the locking nuts are tightened to prevent the bolts working loose.

Always use a straight edge to make sure the belt pulleys are in line and running true. If misaligned, call your dealer or service engineer for technical support.

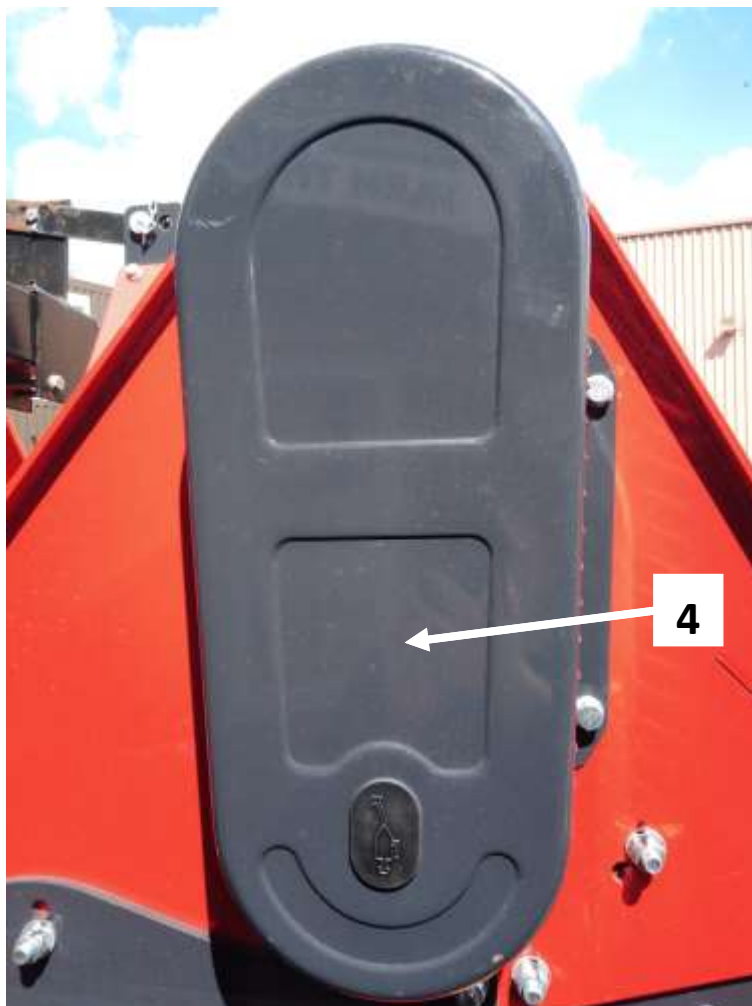



## 6. Hydraulic Fitting & Operation

**Safety:** Ensure tractor and machine is stationary and keys out of ignition before set-up/maintenance.

**Safety:** Before attaching/detaching machinery ensure the hydraulic lift system is in a neutral position.

### Connecting Hydraulics

Always check your tractor's operating manual for the recommended type of hydraulic fluid for your specific tractor. This should also give an idea of the tractor's reservoir capacity and how to check the level of fluid.

Always check your tractor's hydraulic reservoir is topped up before using any hydraulically operated machinery. Your tractor will fill the pipes and RAMs with the hydraulic fluid on first use. So it is always best to check the hydraulic fluid reservoir after your first connection as well.



Start by setting the hydraulic lever on your tractor in to the position to release the hydraulic pressure and turn off the tractor. Please refer to the tractor's owner manual for further instruction.

Both of the hydraulic lines from the implement are the same fitting, if the lines are reversed this will simply reverse the direction of the hydraulic action. The pair of hoses together operate the side shift function of the mower body.

Consult your tractor manual to ensure the machine is connected to a double acting spool, some tractors have a single acting spool (for trailers etc.) or may have more than 1 double acting spool output.

Connect the hydraulic hoses from the machine to the tractor using the quick release couplings. Start your tractor and activate the hydraulics to test the connection. Check there are no leaks from the tractor or implement. Repair or replace if required.

## 6. Hydraulic Fitting & Operation (Continued)

**Safety:** Ensure tractor and machine is stationary and keys out of ignition before set-up/maintenance.

**Safety:** Before attaching/detaching machinery ensure the hydraulic lift system is in a neutral position.

### Disconnecting Hydraulics

Before disconnecting always stop the engine and move the hydraulic control levers backwards and forwards to release any pressure. The same process must be followed when detaching the implement and hydraulic hoses.

Always make sure the protective caps remain on the ends of the hoses when not in use. This will prevent any debris from getting into the hydraulic fittings or the internal lines.

### Operating

Avoid suddenly changing the direction of hydraulic flow/the direction of the machine as this may cause excess pressure and damage to the machine/tractor.



### Hydraulic Side Shift Grease Points

There are two grease points underneath the side shift bracket on the frame and two on the top.

## 7. Servicing & Maintenance

**Safety:** Store all lubricants away from excessive heat, dust, moisture and contaminants.

**Safety:** Ensure tractor and machine is stationary and keys out of ignition before set-up/maintenance.

Grease Type	Multi-purpose lithium based grease (EP1 or EP2 recommended)
Grease Frequency	Check every 4-8 hours (top up if required)

### Greasing & Lubrication Points

Wipe grease nipples with a clean cloth before greasing to avoid injecting any dirt or grit. Press grease into each grease nipple three to five times. We recommend using a hand-held grease gun for best results. If grease nipples will not take grease, remove and clean thoroughly. Also clean lubricant passageway. If you notice any grease points are broken replace or repair them immediately.

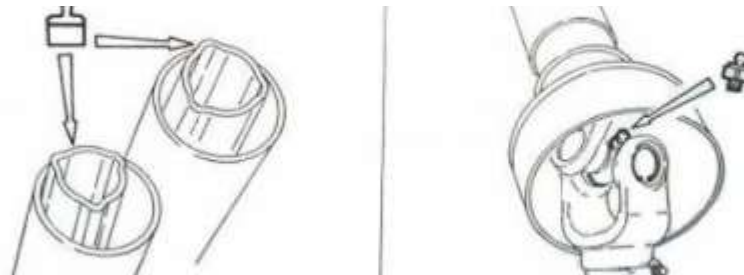

### Greasing The PTO Shaft x2

Grease both grease points on either end of the PTO shaft and apply grease to the inner shaft.

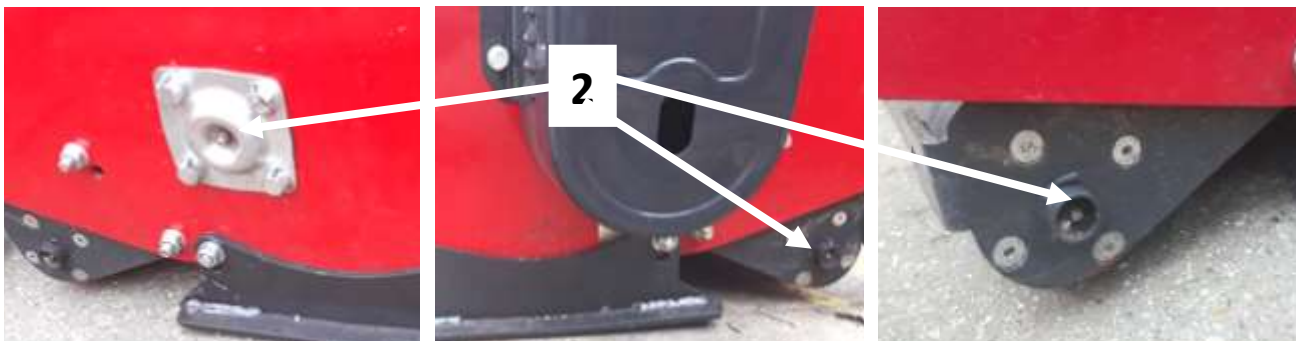

### Greasing The Blade Rotor Bearings x2

Grease both bearings on each end of the rotor. One is on the side body panel and the other one can be reached through the access hole in the belt guard.

### Greasing The Roller Bearings x2

Apply grease to both of the rear roller bearings **2**. There are easy to access grease points on the left and right of the roller on the outside of the brackets.

### Hydraulic ram for side shift x4

There are two grease points underneath on the side shift frame and two on the top.



## 7. Servicing & Maintenance (Continued)

**Safety:** Store all lubricants away from excessive heat, dust, moisture and contaminants.

**Safety:** Ensure tractor and machine is stationary and keys out of ignition before set-up/maintenance.

### Other Maintenance

**Blades:** Check condition of the blades and replace if worn/broken. Always take care when handling blades, wear gloves and use suitable tools for changing blades. If blades are replaced check they are balanced in order to avoid any excessive vibration.

**Belts:** Check the condition of belts, if worn or frayed replace. Adjust the belt tension if required.

**Oils:** Ensure oil levels are checked and topped up when needed. Replace any oils per the schedule.

**PTO Shaft:** Check the condition of your PTO shaft and replace if worn or damaged immediately.

**Cleaning:** Ensure the mower deck & blades are cleaned of mud/grass. Remove debris is from moving parts to prevent entanglement. Do not spray bearings when cleaning with a high pressure washer.

**Bearings:** Check the bearings on the blade rotor and the rear roller. If the oil seals are damaged debris may enter the bearings. Clean and replace with new bearings if necessary. Run the mower without a load for 3-5 minutes to check bearings are operating smoothly.

**Paintwork:** Re-coat any damaged paintwork to prevent corrosion.

**Storage:** Store the machine in a dry, level area and ensure it is stable and unable to move or overturn.

**Skids:** Check the condition of the side skids and replace if worn.

**Hydraulics:** Check hydraulic pipes, connectors and RAMs for signs of leaks. Carry out repairs to hydraulic parts or replace as required. Check for damage to hydraulic hoses and replace.

\*The periods recommended are based on normal operating conditions. Severe or unusual conditions may require more frequent maintenance.

# 8. Parts Diagram 1

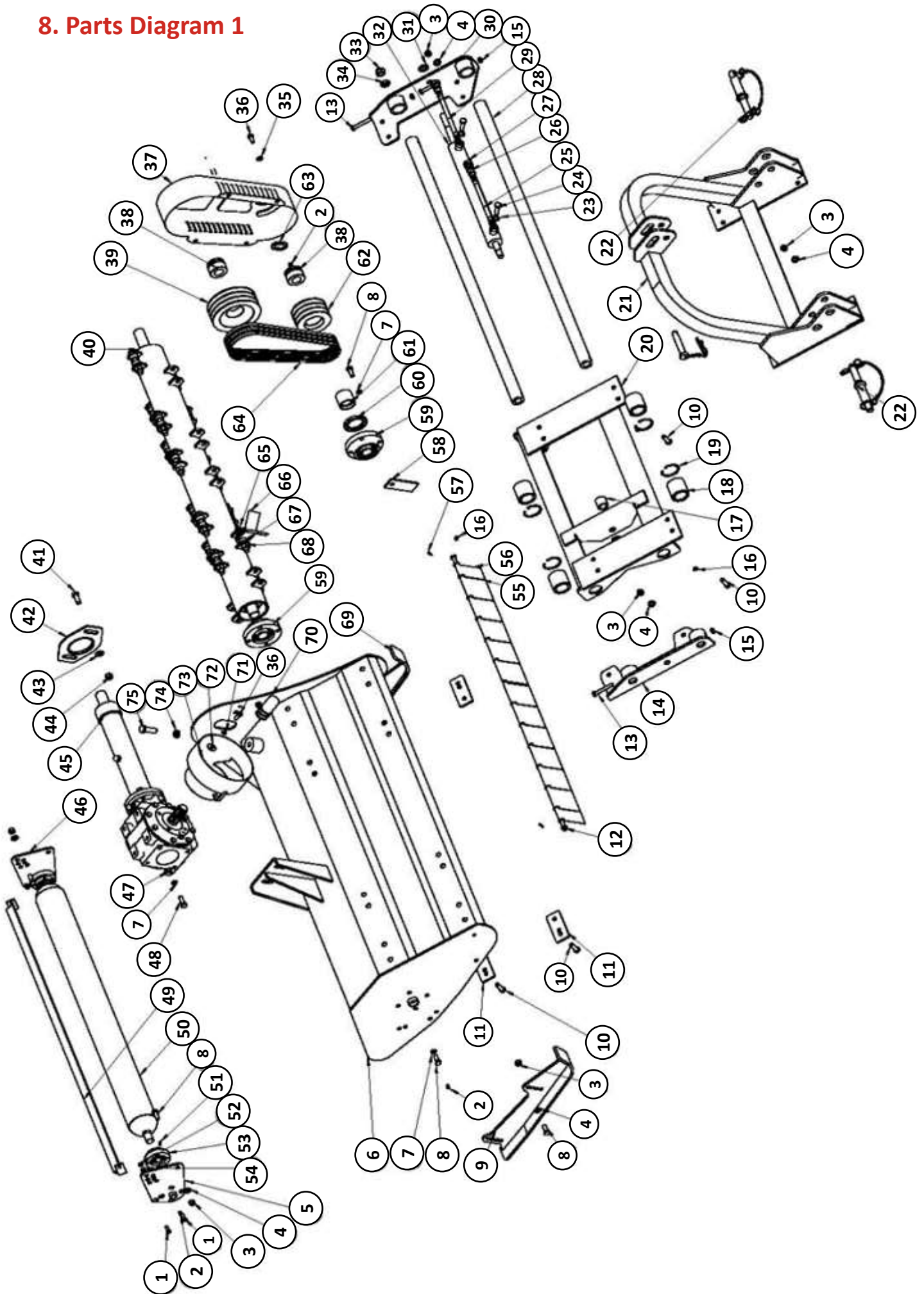

## 9. Parts List 1

Dia No.	Number	Part Number	Part Description	Qty
1	501030185	GB70.3-M8X25	M8 bolt	10
2	509010008	GB1152-M8X1	Grease point	4
3	503010763	DIN985-M12	12 nut	24
4	506010057	GB97.1-12	12 washer	32
5	801160001	EFG120.017	Roller support bracket right	1
6-3	801680024	EFGCHM120.011B	125 body	1
6-5	801700024	EFGCHM140.011B	145 body	1
6-8	801730024	EFGCHM170.011B	175 body	1
6-9	801740001	EFGCHM200.011A	200 body	1
6-10	801750001	EFGCHM220.011A	220 body	1
7	506030037	GB93-12	12 spring washer	12
8	501011126	GB5783-M12X30	M12 bolt	16
9	801240019	EFGC120.013	Left skid base	1
10	501011128	GB5783-M12X40	M12 bolt	16
11	701680001	EFGCHM120.101	Underbody plate	4
12-3	700960009	EF120.00.123	125 fender shaft	1
12-5	700980005	EF140.00.123	145 fender shaft	1
12-8	701010005	EF170.00.123	175 fender shaft	1
12-9	701010006	EF200.00.123	200 fender shaft	1
12-10	701010007	EF220.00.123	220 fender shaft	1
13	501011121	GB5783-M10X70	M10 bolt	4
14	801680021	EFGCHM120.015	Side shift bracket/plate	1
15	503010762	DIN985-M10	10 nut	6
16	509010017	GB1153-M6X45°	M6 grease point M6	4
17	701600026	EFGCH120.101	Sleeve	1
18	701600028	EFGCH120.103	Sleeve	4
19	506060182	GB893.1-60	Circlip	4
20-1	801680009	EFGCHM120.013	125-175 side shift rack	1
20-2	801740004	EFGCHM200.013	200-220 side shift rack	1
21-1	801680014	EFGCHM120.014B	A-frame bracket 125-175	1
21-2	801740006	EFGCHM200.014	A-frame bracket 200-220	1
22	802480066	EFAG140.014	Lower linkage pin	2
23	516010004	TDQ-12	Bronze washer	4
24	501014706	GB3541-M12X1.25	M12 bolt	2
25	701600001	EFGCH120.011	(1500) oil pipe	1
26	705380114	RK120.401	Connector	2
27	703820055	QUICK-COUPLING-G1/2-G	G1/2 quick coupling	2
28-2	701600030	EFGCH120.104	Guide rail (L=1218) 125-175	2
28-3	701600031	EFGCH120.104A	Guide rail (L=1342) 200-220	2
29	701600005	EFGCH120.011A	(1900) oil pipe	1

## 9. Parts List 1 (Continued)

Dia No.	Part Ref.	Part Number	Part Description	Qty
30	801680007	EFGCHM120.012	Side shift bracket/plate	1
31	506010060	GB97.1-18	18 washer	2
32-1	701600003	EFGCH120.012A	125-175 cylinder RAM	1
32-2	701600002	EFGCH120.012	200 cylinder RAM	1
32-3	701600004	EFGCH120.012B	200-220 cylinder RAM	1
33	503010741	DIN985-M18X1.5	18 nut	2
34	503010148	GB6173-M18X1.5	18 nut	1
35	506010056	GB97.1-10	10 washer	22
36	501011112	GB5783-M10X25	M10 bolt	8
37-1	701250006	EFGC120.111	Belt cover (H=100) 3 belt 125-175	1
37-2	706160004	EFGC200.111	Belt cover (H=120) 4 belt 200-220	1
38-1	515010001	REACH04-35X60	Swellable sleeve for 3 belts	2
38-2	515010007	REACH04-40X65	Swellable leeve for 4 belts	2
39-1	701160007	EFG120.106A	Big top pulley 3 belt 125-175	1
39-2	701160040	EFG120.106B	Big top pulley 4 belt 200-220	1
40-3	801160038	EFG120.013A	125 blade axle	1
40-5	801180010	EFG140.013A	145 blade axle	1
40-8	801210010	EFG170.013A	175 blade axle	1
40-9	802080080	EFG200.013A-G2	200 blade axle	1
40-10	802080085	EFG220.013A	220 blade axle	1
41-1	501011141	GB5783-M14X35	M14 bolt	2
41-2	501011142	GB5783-M14X40	M14 bolt	2
42-1	701240007	EFGC120.102A	Lath 125-175	1
42-2	706160003	EFGC200.102	Lath 200-220	1
43	506010058	GB97.1-14	14 washer	2
44	503010764	DIN985-M14	14 nut	2
45	80124002.	EFGCH140.015	Gearbox with shaft <i>see diagram 2</i>	1
46	801160004	EFG120.018	Roller support bracket left	1
47	506010037	GB96.1-12	12 washer	4
48	501011127	GB5783-M12X35	M12 bolt	4
49-3	801160030	EFG120.024	125 scraper bar	1
49-5	801180008	EFG140.024	145 scraper bar	1
49-8	801210008	EFG170.024	175 scraper bar	1
49-9	801130012	EFG200.024	200 scraper bar	1
49-10	801130013	EFG220.024	220 scraper bar	1

## 9. Parts List 1 (Continued)

Dia No.	Part Ref.	Part Number	Part Description	Qty
50-3	801160017	EFG120.012	125 roller (L=1227)	1
50-5	801180004	EFG140.012	145 roller (L=1427)	1
50-8	801210004	EFG170.012	175 roller (L=1727)	1
50-9	801160036	EFG200.012	200 roller (L=1977)	1
50-10	801160041	EFG220.012	220 roller (L=2177)	1
51	509010007	GB1152-M6	Grease point	2
52	503010761	DIN985-M8	8 nut	2
53	511040007	EF100.00.012	UC205 roller bearing	2
54	506010055	GB97.1-8	8 washer	2
55	700920108	EF100.00.122	Fender regular	12/14/16/18/20
56	700920107	EF100.00.121	Fender small	1
57	508011473	GB879.1-4X25	Pin	2
58	701160033	EFG120.103	Underbody plate	1
59-1	511040032	UC207	Rotor bearing 125-175	2
59-2	511040009	UC208	Rotor bearing 200-220	2
60-1	510020417	GB13871-FB-55X80X8	Oil seal	1
60-2	510020397	CFW-60X85X8	Oil seal	1
61-1	705380014	RK120.109A	125-175 sleeve (L=48)	1
61-2	702080005	G2-150.105	200-220 sleeve	1
62-1	701160006	EFG120.105A	Small bottom pulley (3 belt) 125-175	1
62-2	701160034	EFG120.105B	Small bottom pulley (4 belt) 200-220	1
63	701240046	EFGC120.138	U cover	1
64	514010001	17X991	Belt B991	3 / 4
65	501014730	ZDLS-M16X1.5X85	M16 bolt	Pg.23
66	701240009	EFGC120.104A	Hammer blade	Pg.23
67			N/A	
68	503010740	DIN985-M16X1.5	16 nut	Pg.23
69	801240022	EFGC120.014	Right skid base	1
70	702420030	EF100.00.177	Shaft cover sleeve	1
71	506030036	GB93-10	10 spring washer	4
72	506010036	GB96.1-10	10 washer	4
73	703400008	FM120.00.199	PTO guard cover	1
74	503010137	GB6173-M16X1.5	16 nut	1
75	501011905	GB5786-M16X1.5X50	M16 bolt	1

# 10. Parts Diagram 2

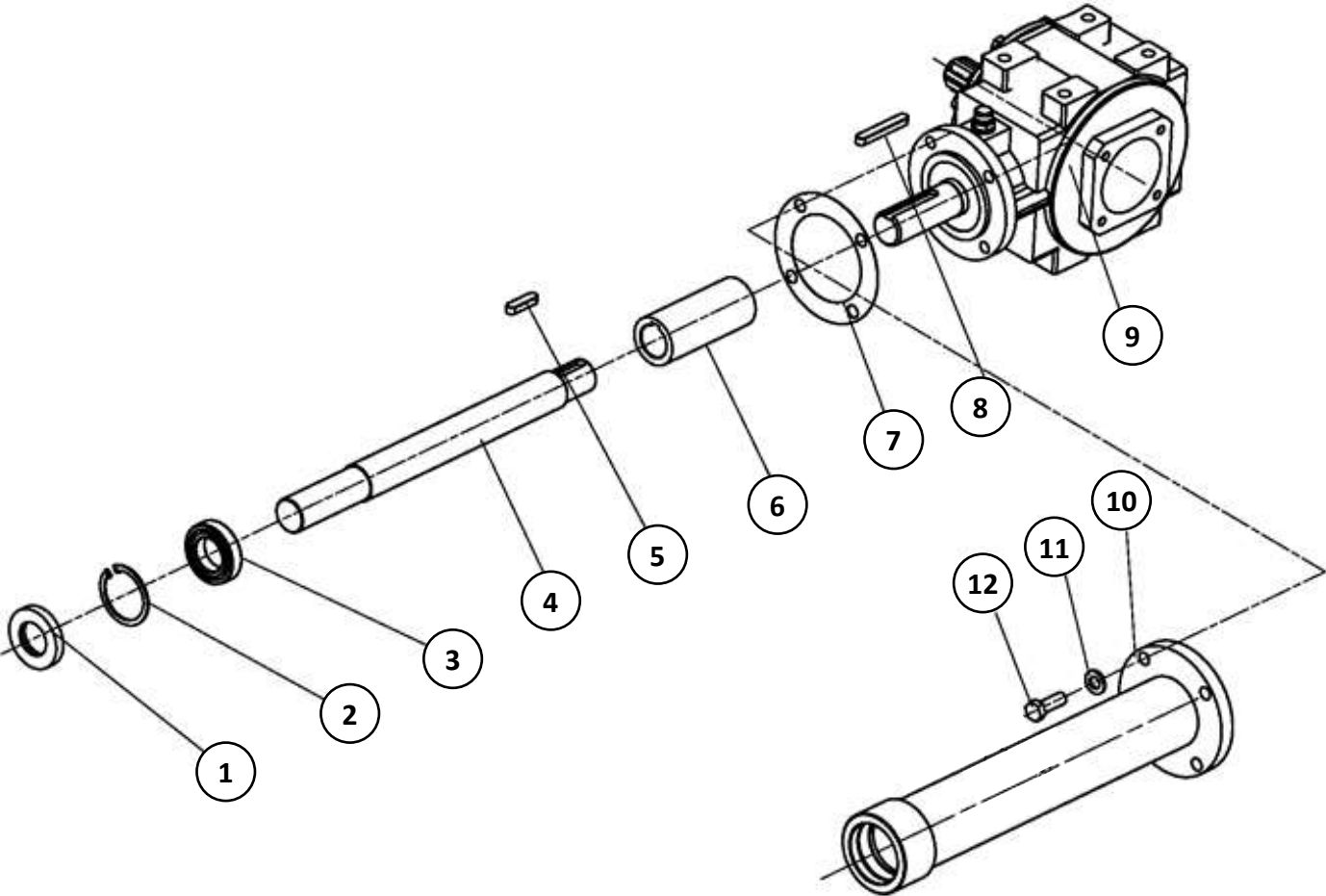

## 11. Parts List 2

Dia No.	Number	Part Number	Part Description	Qty
1-1	510020640	GB13871-FB-35X72X12	125-175 oil seal	1
1-2	510020405	GB13871-FB-40X80X10	200-220 oil seal	1
2-1	506060188	GB893.1-72	125-175 72 circlip	1
2-2	506060191	GB893.1-80	200-220 80 circlip	1
3-1	511021666	GB276-6207-2Z	125-175 6207-2Z bearing	1
3-2	511021529	GB276-6208-2Z	200-220 6208-2Z bearing	1
4-3	701250003	EFGC130.133A	125-175 shaft	1
4-4	701600034	EFGCH200.166B EFGCHZ/M/H-200	200-220 shaft (L=638)	1
5	507010086	GB1096-A-10X8X40	A10X40 key	1
6	701240025	EFGC120.132	Sleeve	1
7	701240024	EFGC120.131	Gasket	1
8	507010091	GB1096-A-10X8X70	A10X70 key	1
9-1	801240040	XH50.300Z.02 gearbox	125-175 gearbox	1
9-2	801380003	XH50.300Z.02-200	200-220 gearbox	1
10-2	801240004	EFGC120.018A	125-175 shaft cover	1
10-3	801600032	EFGCH200.026A EFGCHZ/M/H-200	200-220 shaft cover (L=640)	1
11	506030037	GB93-12	12 washer	4
12	505011445	GB70.1-M12X35	M12X35 bolt	4



# 12. Parts Diagram 3

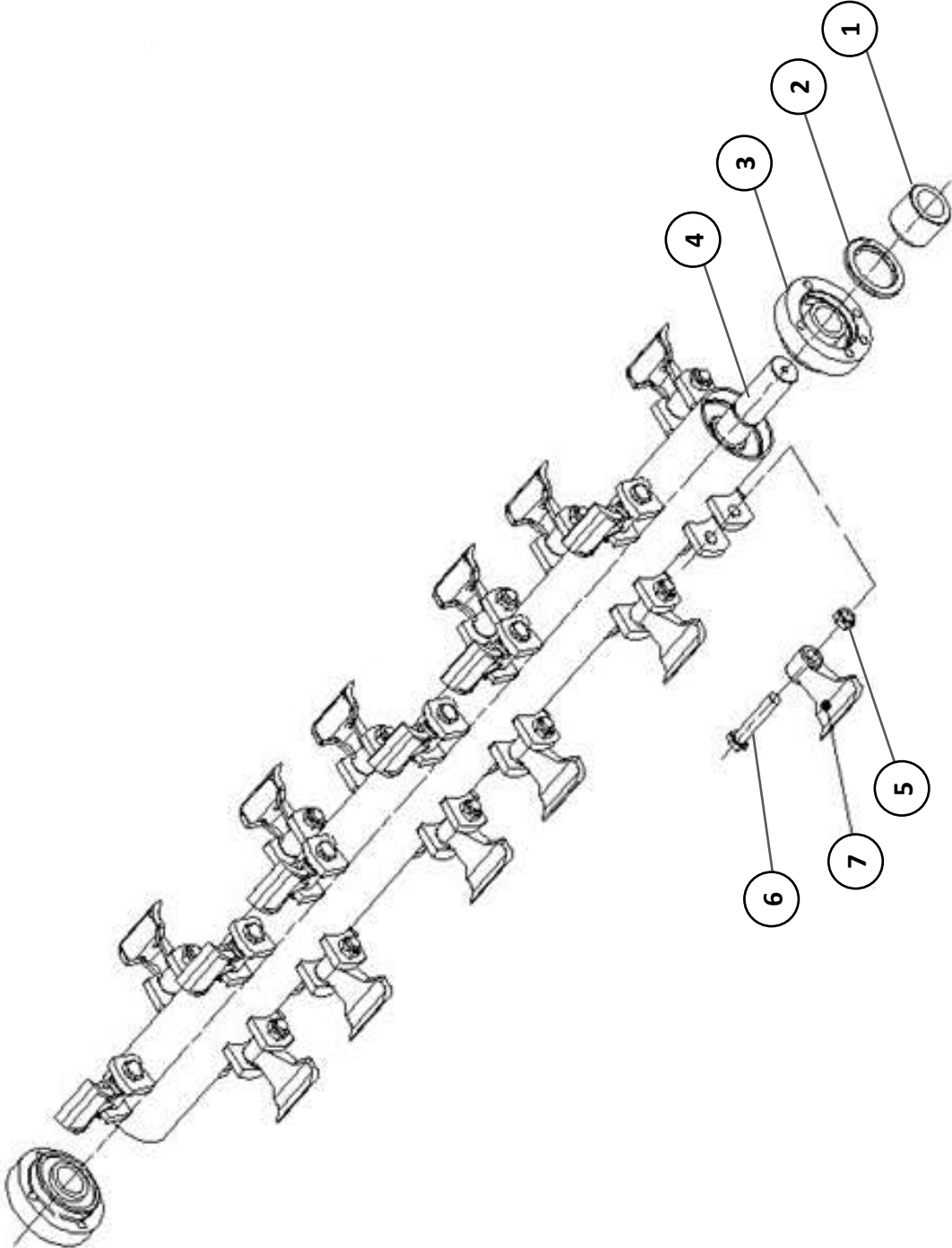



### 13. Parts List 3 [125-175]

Dia No.	Number	Part Number	Part Description	Qty
1	705380014	RK120.109A	Bush	1
2	510020417	GB13871-FB-55X80X8	FB55X80X8 oil seal	1
3	511040032	UC207 90207	UC207 bearing	2
4-5	801180010	EFG140.013A	145 rotor	1
4-8	801210010	EFG170.013A	175 rotor	1
5	503010740	DIN985-M16X1.5	M16X1.5 nut	20 24 28
6	501014730	EFGC120.200A	M16X1.5X85 bolt	20 24 28
7	701240010	EFGC120.104A	Hammer blade	20 24 28

### 14. Parts List 3 [200-220]

Dia No.	Number	Part Number	Part Description	Qty
1	702080005	G2-150.105	Bush	1
2	510020397	CFW-60X85X8	FB60X85X8 oil seal	1
3	511040009	UC208	90208 bearing	2
4-1	802080080	EFG200.013A-G2	200 rotor	1
4-2	802080085	EFG220.013A	220 rotor	1
5	503010740	DIN985-M16X1.5	M16X1.5 nut	32 36
6	501014730	EFGC120.200A	M16X1.5X85 bolt	32 36
7	701240010	EFGC120.104A	Hammer blade	32 36

## 15. Notes

## PTO Shaft Resizing

**Safety:** Ensure tractor and machine is stationary and keys out of ignition before carrying out any work.

If you are not confident in carrying out the work consult your local supplier or mechanic.

Most PTO driven implements are supplied with a standard sized PTO shaft. As all tractors vary this often means cutting it down to size. Always replace worn or damaged PTO shafts.

Attach the machine to the tractor without the PTO shaft, raise the linkage so the PTO shaft is level/horizontal. Measure the length between tractor PTO and the machine's shaft. If the compressed (closed) PTO shaft length exceeds the one measured here then the driveline will need to be cut.

1. PTO length adjustment, first remove PTO shaft shielding.



2. Shorten the driveline tubes to proper equal lengths.



3. Tidy edges of the drive tube with a file and clean all fillings from the tubes.



4. Shorten the equally long guard tubes to the same length as the driveline tubes.



5. Grease the internal driveline tube.

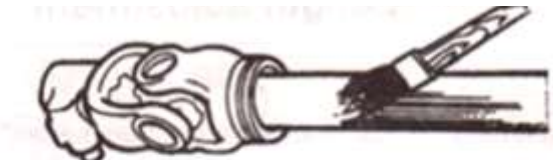

6. Fit the guard on the shaft.



7. Make sure that the length allows for at least 16cm (6 inches) of overlap.

## Winton Product Warranty

We always strive to create great products, but when something does go wrong we have a strong network of resellers on hand throughout the UK to help out.

### Warranty Claims

Before you get in touch here are 5 pieces of information your Winton reseller will need to progress your claim:

- Your invoice/order details - to include date of purchase
- Machine model number
- Machine serial number
- Details of the fault
- Images/videos of the fault

### The Terms & Conditions

All products purchased as new are covered under our 12 month warranty from the date of purchase. During this period Winton will repair or replace defective parts free of charge. This warranty is given on the proviso that the product has been used and maintained according to the Owner's Manual.

Warranty is carried out on a return to reseller / manufacturer basis and excludes any labour or delivery / collection costs.

### Exclusions

- Wearing parts are excluded; including but not limited to blades, belts and bearings.
- Modification of the product in any way will cease the manufacturers warranty.
- The machine is warranted for one year to the original purchaser, resale within the period will cease the warranty.
- Damage in transit is not covered. Claims will need to be made through the courier or your Winton reseller directly.
- Compensation for down-time, labour or loss of earnings is not covered by the warranty.
- No warranty extension will be granted for replacement parts fitted.
- Damage caused by continued use of a faulty machine will not be covered.

Your **Winton** reseller will provide their own terms and conditions upon purchase, consult this for any additional queries.

## Trouble-Shooting

**Safety:** Ensure tractor and machine is stationary and keys out of ignition before set-up/maintenance.

WFL/WHF Problem	Solution
Belts Slipping	Clean the mower deck. Adjust the belt tension. Replace belts.
Patches of uncut grass	Mow at 540 RPM, check PTO speed and tractor power output. Change into a lower gear on the tractor. Tighten belts. Replace any missing/damaged blades.
Excessive vibration	Check and replace blades. Replace or tension belts. Align/replace belt pulleys. Remove belt guard and clean debris from belt area. Check PTO shaft for damage and replace.
Gearbox noisy	Check oil level and top up if required. Extract any oil/debris and replace with new oil.
Blades scalping	Raise cutting height. Change mowing pattern/route. Reduce speed when turning.
Uneven cut	Change into a lower gear on the tractor. Level the mower using tractor linkage. Replace any missing/damaged blades.
Tractor loaded down by mower	Mow at 540 RPM. Change into a lower gear on the tractor. Clean off the mower. Check power output on your tractor.
Hydraulics leaking	Tighten hydraulic fittings and connectors
Hydraulic connectors don't fit	Visit a tractor dealer for hydraulic converters (1/2" BSP)

Always consult your **Winton** dealer if you have any questions about your machine.

## Notes

## Notes



**W Winton**

[www.wintonmachinery.co.uk](http://www.wintonmachinery.co.uk)